

General Description

FSMOS[®] MOSFET is based on Oriental Semiconductor's unique device design to achieve low $R_{DS(ON)}$, low gate charge, fast switching and excellent avalanche characteristics. The low V_{th} series is specially designed to use in synchronous rectification power systems with low driving voltage.

Features

- Low $R_{DS(ON)}$ & FOM
- Extremely low switching loss
- Excellent reliability and uniformity
- Fast switching and soft recovery



Applications

- PD charger
- Motor driver
- Switching voltage regulator
- DC-DC convertor
- Switched mode power supply

Key Performance Parameters

Parameter	Value	Unit
$V_{DS, min} @ T_{j(max)}$	40	V
$I_{D, pulse}$	600	A
$R_{DS(ON) max} @ V_{GS}=10V$	1.5	m Ω
Q_g	96.8	nC

Marking Information

Product Name	Package	Marking
SFS04R02GF	PDFN5*6	SFS04R02G

Package & Pin information

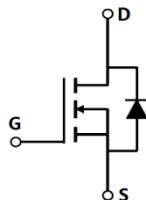

Absolute Maximum Ratings at $T_j=25^{\circ}\text{C}$ unless otherwise noted

Parameter	Symbol	Value	Unit
Drain source voltage	V_{DS}	40	V
Gate source voltage	V_{GS}	± 20	V
Continuous drain current ¹⁾ , $T_C=25^{\circ}\text{C}$	I_D	200	A
Pulsed drain current ²⁾ , $T_C=25^{\circ}\text{C}$	$I_{D, pulse}$	600	A
Continuous diode forward current ¹⁾ , $T_C=25^{\circ}\text{C}$	I_S	200	A
Diode pulsed current ²⁾ , $T_C=25^{\circ}\text{C}$	$I_{S, Pulse}$	600	A
Power dissipation ³⁾ , $T_C=25^{\circ}\text{C}$	P_D	132	W
Single pulsed avalanche energy ⁵⁾	E_{AS}	200	mJ
Operation and storage temperature	T_{stg}, T_j	-55 to 150	$^{\circ}\text{C}$

Thermal Characteristics

Parameter	Symbol	Value	Unit
Thermal resistance, junction-case	$R_{\theta JC}$	0.95	$^{\circ}\text{C/W}$
Thermal resistance, junction-ambient ⁴⁾	$R_{\theta JA}$	62	$^{\circ}\text{C/W}$

Electrical Characteristics at $T_j=25^{\circ}\text{C}$ unless otherwise specified

Parameter	Symbol	Min.	Typ.	Max.	Unit	Test condition
Drain-source breakdown voltage	BV_{DSS}	40			V	$V_{GS}=0\text{ V}, I_D=250\ \mu\text{A}$
Gate threshold voltage	$V_{GS(th)}$	1.0		2.5	V	$V_{DS}=V_{GS}, I_D=250\ \mu\text{A}$
Drain-source on-state resistance	$R_{DS(ON)}$		1.25	1.50	$\text{m}\Omega$	$V_{GS}=10\text{ V}, I_D=55\text{ A}$
Drain-source on-state resistance	$R_{DS(ON)}$		2.0	3.0	$\text{m}\Omega$	$V_{GS}=6\text{ V}, I_D=55\text{ A}$
Gate-source leakage current	I_{GSS}			100	nA	$V_{GS}=20\text{ V}$
				-100		$V_{GS}=-20\text{ V}$
Drain-source leakage current	I_{DSS}			1	μA	$V_{DS}=40\text{ V}, V_{GS}=0\text{ V}$

Dynamic Characteristics

Parameter	Symbol	Min.	Typ.	Max.	Unit	Test condition
Input capacitance	C_{iss}		6587		pF	$V_{GS}=0\text{ V}$, $V_{DS}=20\text{ V}$, $f=100\text{ kHz}$
Output capacitance	C_{oss}		2537		pF	
Reverse transfer capacitance	C_{rss}		178		pF	
Turn-on delay time	$t_{d(on)}$		26.6		ns	$V_{GS}=10\text{ V}$, $V_{DS}=20\text{ V}$, $R_G=2\ \Omega$, $I_D=20\text{ A}$
Rise time	t_r		9.3		ns	
Turn-off delay time	$t_{d(off)}$		96		ns	
Fall time	t_f		39.3		ns	

Gate Charge Characteristics

Parameter	Symbol	Min.	Typ.	Max.	Unit	Test condition
Total gate charge	Q_g		96.8		nC	$V_{GS}=10\text{ V}$, $V_{DS}=20\text{ V}$, $I_D=20\text{ A}$
Gate-source charge	Q_{gs}		14.5		nC	
Gate-drain charge	Q_{gd}		18.4		nC	
Gate plateau voltage	$V_{plateau}$		2.7		V	

Body Diode Characteristics

Parameter	Symbol	Min.	Typ.	Max.	Unit	Test condition
Diode forward voltage	V_{SD}			1.3	V	$I_S=20\text{ A}$, $V_{GS}=0\text{ V}$
Reverse recovery time	t_{rr}		66.2		ns	$V_R=20\text{ V}$, $I_S=20\text{ A}$, $di/dt=100\text{ A}/\mu\text{s}$
Reverse recovery charge	Q_{rr}		66.1		nC	
Peak reverse recovery current	I_{rrm}		2		A	

Note

- 1) Calculated continuous current based on maximum allowable junction temperature.
- 2) Repetitive rating; pulse width limited by max. junction temperature.
- 3) P_d is based on max. junction temperature, using junction-case thermal resistance.
- 4) The value of $R_{\theta JA}$ is measured with the device mounted on 1 in 2 FR-4 board with 2oz. Copper, in a still air environment with $T_a=25\text{ }^\circ\text{C}$.
- 5) $V_{DD}=30\text{ V}$, $V_{GS}=10\text{ V}$, $L=0.3\text{ mH}$, starting $T_j=25\text{ }^\circ\text{C}$.

Electrical Characteristics Diagrams

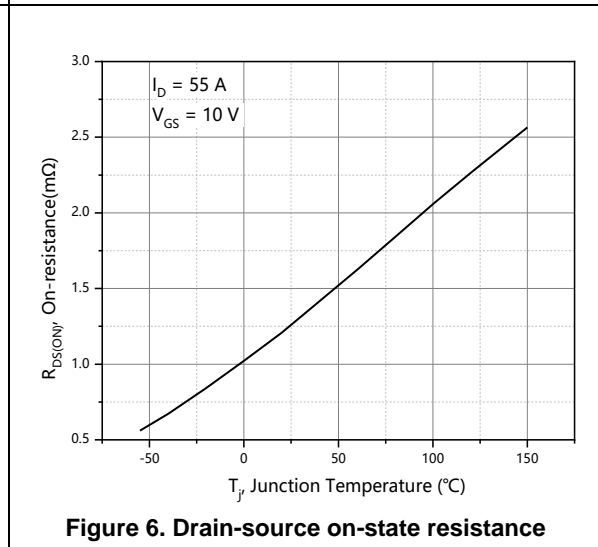
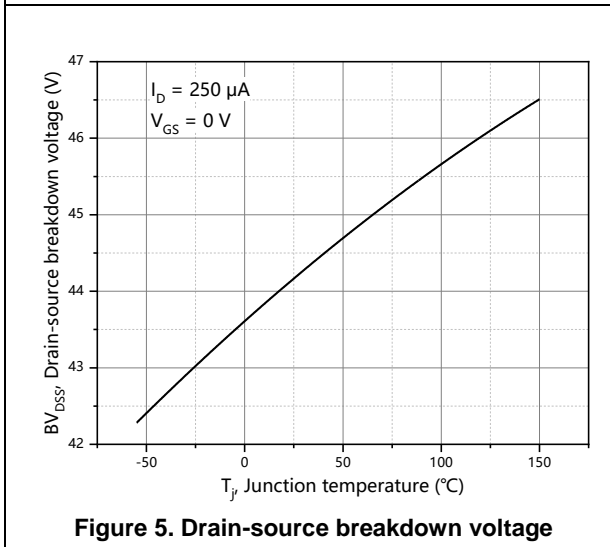
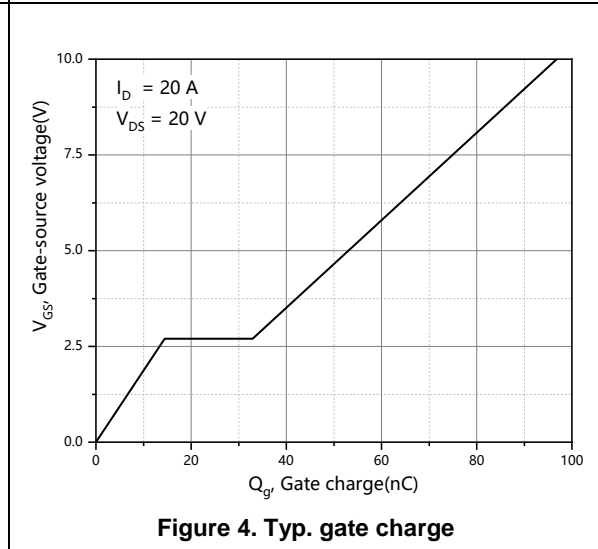
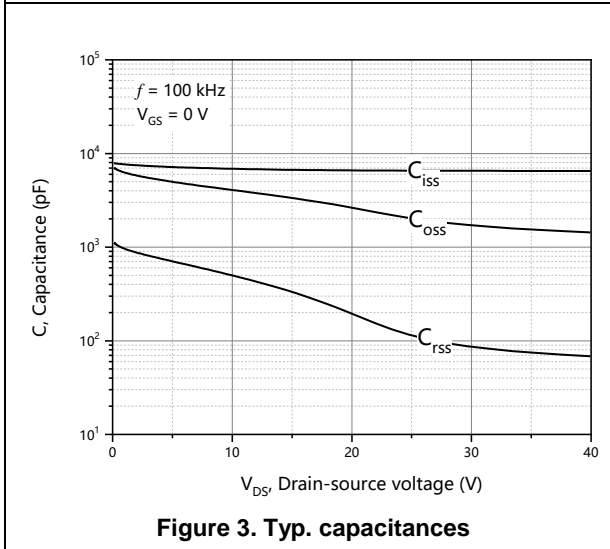
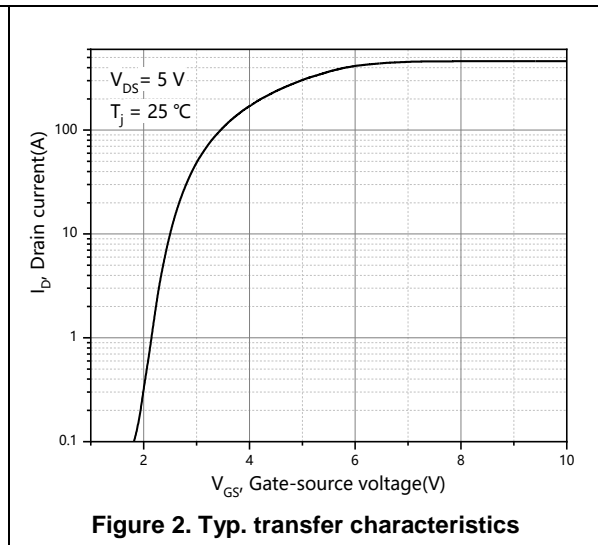
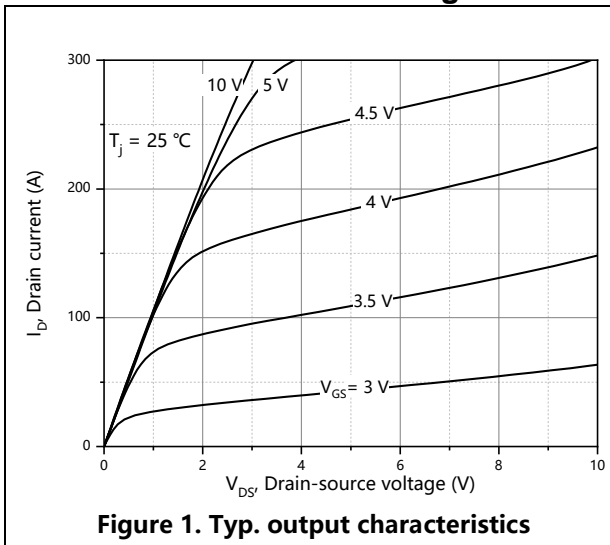

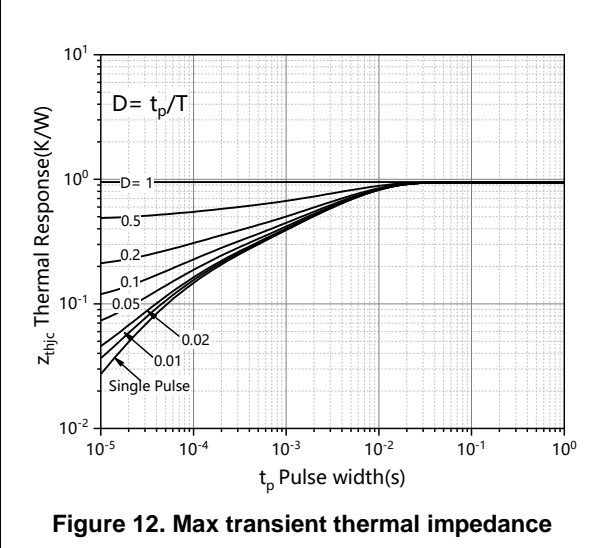
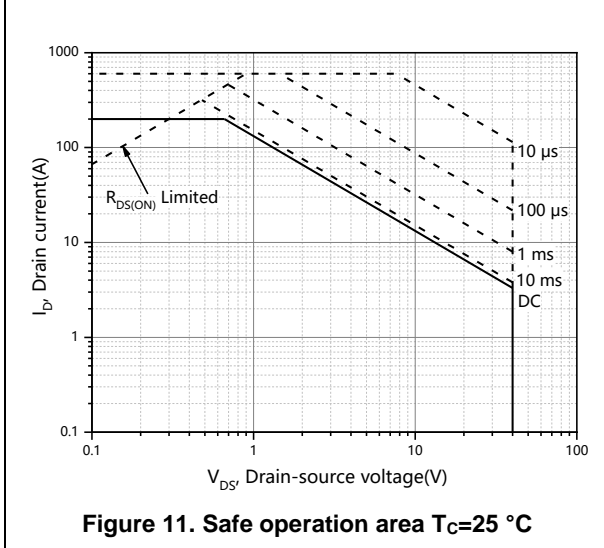
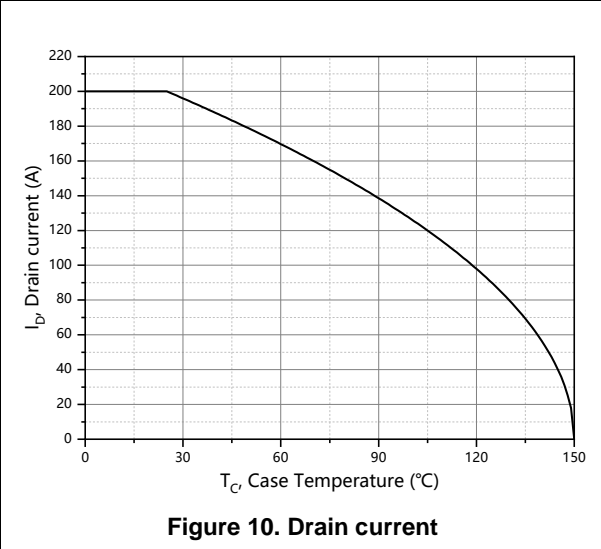
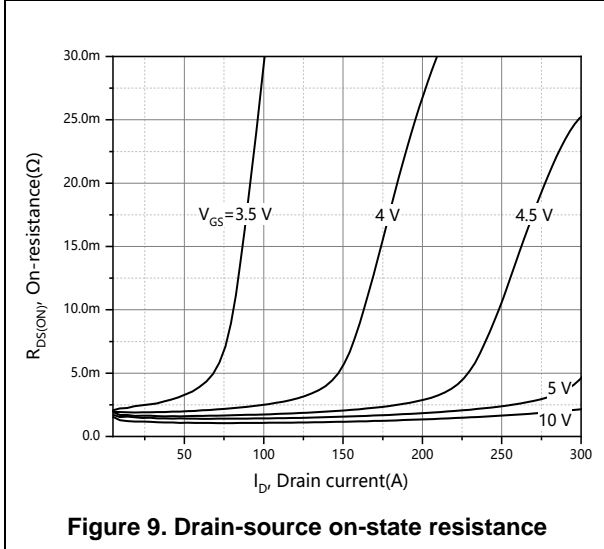
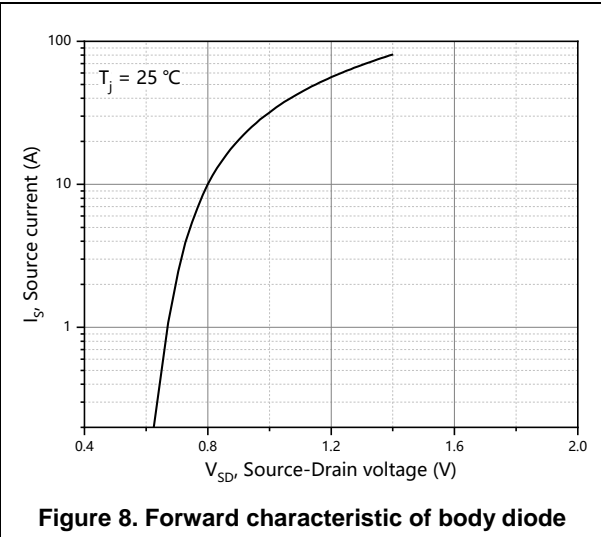
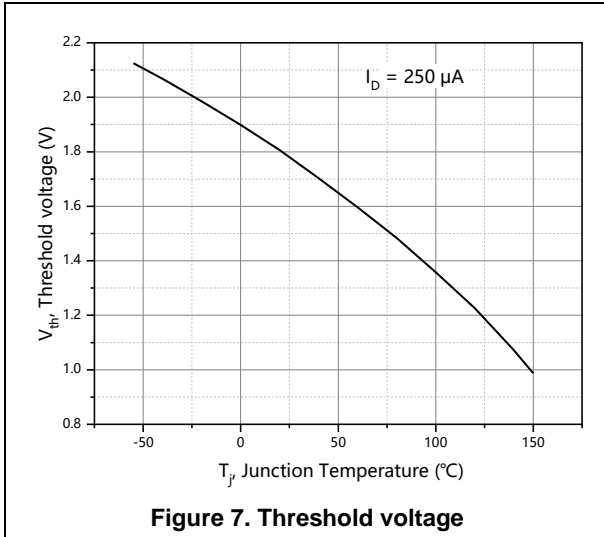

Test circuits and waveforms



Figure 1. Gate charge test circuit & waveform



Figure 2. Switching time test circuit & waveforms

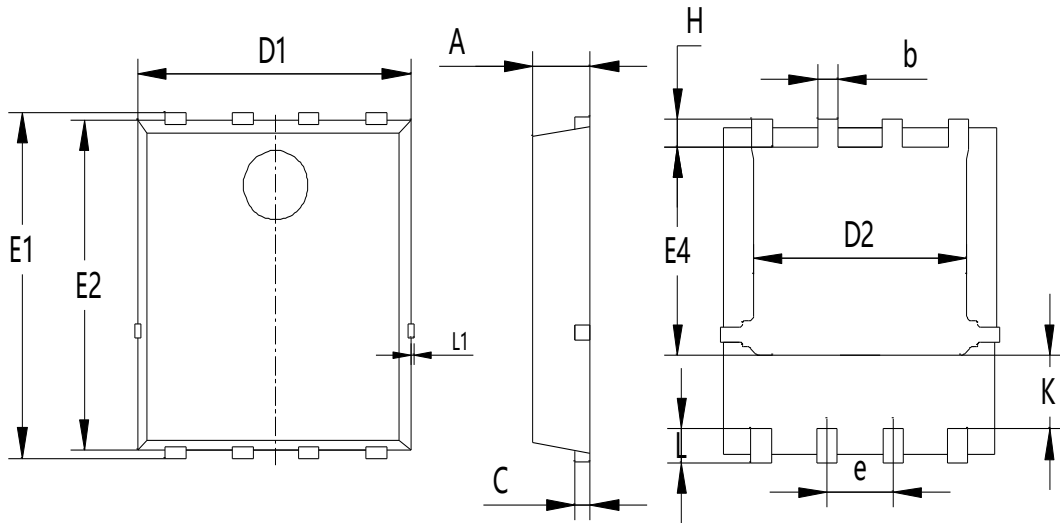

Figure 3. Unclamped inductive switching (UIS) test circuit & waveforms



Figure 4. Diode reverse recovery test circuit & waveforms

Package Information



Symbol	mm		
	Min	Nom	Max
A	1.00	1.10	1.20
b	0.30	0.40	0.50
c	0.154	0.254	0.354
D1	5.00	5.20	5.40
D2	3.80	4.10	4.25
e	1.17	1.27	1.37
E1	5.95	6.15	6.35
E2	5.66	5.86	6.06
E4	3.52	3.72	3.92
H	0.40	0.50	0.60
L	0.30	0.60	0.70
L1	0.12 REF		
K	1.15	1.30	1.45

Version 1: PDFN5*6-P package outline dimension

Package Information

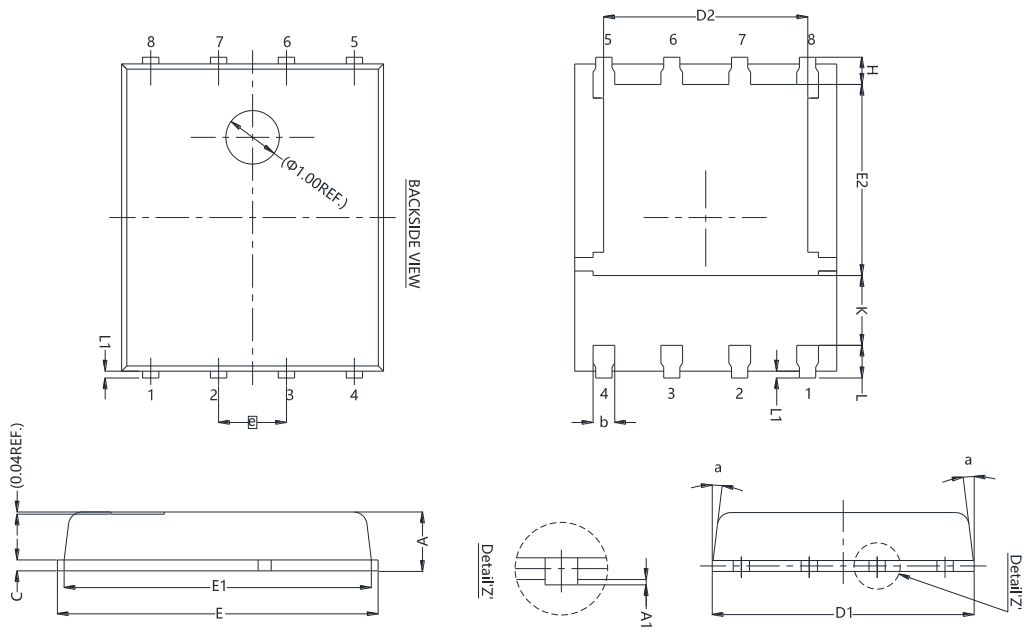

Symbol	mm		
	Min	Nom	Max
A	0.90	1.00	1.10
A1	0.00	-	0.05
b	0.33	0.41	0.51
C	0.20	0.25	0.30
D1	4.80	4.90	5.00
D2	3.61	3.81	3.96
E	5.90	6.00	6.10
E1	5.70	5.75	5.80
E2	3.38	3.58	3.78
e	1.27 BSC		
H	0.41	0.51	0.61
K	1.10	-	-
L	0.51	0.61	0.71
L1	0.06	0.13	0.20
a	0°	-	12°

Version 2: PDFN5*6-M package outline dimension

Ordering Information

Package Type	Units/ Reel	Reels / Inner Box	Units/ Inner Box	Inner Boxes/ Carton Box	Units/ Carton Box
PDFN5*6-P	5000	2	10000	5	50000
PDFN5*6-M	5000	2	10000	5	50000

Product Information

Product	Package	Pb Free	RoHS	Halogen Free
SFS04R02GF	PDFN5*6	yes	yes	yes

Legal Disclaimer

The information given in this document shall in no event be regarded as a guarantee of conditions or characteristics. With respect to any examples or hints given herein, any typical values stated herein and/or any information regarding the application of the device, Oriental Semiconductor hereby disclaims any and all warranties and liabilities of any kind, including without limitation, warranties of non-infringement of intellectual property rights of any third party.

For further information on technology, delivery terms and conditions and prices, please contact the Oriental Semiconductor sales representatives (www.orientalsemi.com).

© Oriental Semiconductor Co.,Ltd. All Rights Reserved /