

PD030120E2H / PD030120E2H_G

1200V Silicon Carbide Diode

Features

- 1200-Volt Schottky Rectifier
- Shorter recovery time
- High-speed switching possible
- High-Frequency Operation
- Temperature-Independent Switching Behavior
- Extremely Fast Switching
- Positive Temperature Coefficient on VF
- RoHS Compliant

Applications

- Switch Mode Power Supplies
- Power Factor Correction
- Motor Drives
- HID Lighting

Package Outline

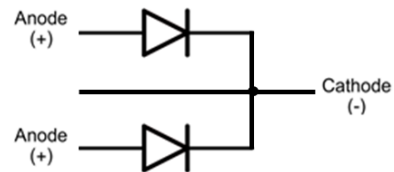
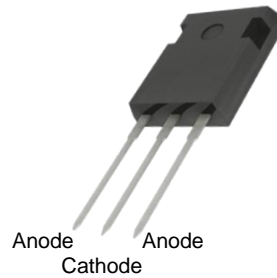

Absolute Maximum Ratings

Symbol	Parameter	Value	Units
V_{RRM}	Repetitive Peak Reverse Voltage	1200	V
V_{RSM}	Surge Peak Reverse Voltage	1200	V
V_{DC}	DC Blocking Voltage	1200	V
I_F	Continuous Forward Current $T_C = 25^\circ\text{C}$ $T_C = 150^\circ\text{C}$	50 / 100 15 / 30	A
I_{FRM}	Repetitive Peak Forward Current $T_C = 110^\circ\text{C}$	120 / 240	A
I_{FSM}	Non-Repetitive Forward Surge Current (PW=10ms sinusoidal) $T_C = 25^\circ\text{C}$ $T_C = 110^\circ\text{C}$	75 / 150 60 / 120	A
P_D	Power Dissipation $T_C = 25^\circ\text{C}$	176 / 352	W
T_J, T_{stg}	Operating Junction and Storage Temperature	-55 to +175	$^\circ\text{C}$

* Per Leg / Per Device

Electrical Characteristics (Per Leg)T_C = 25°C unless otherwise noted

Symbol	Parameter	Test Conditions	Min	Typ	Max	Units
V _F	Forward Voltage	I _F = 15A, T _C = 25°C I _F = 15A, T _C = 175°C	--	1.5 2.0	1.8 2.4	V
I _R	Reverse Current	V _R = 1200V T _C = 25°C V _R = 1200V T _C = 175°C	--	25 50	55 550	uA
Q _C	Total Capacitive Charge	V _R = 800V	--	99	--	nC
C	Total Capacitance	V _R = 0V, T _J = 25°C, f = 1MHz V _R = 800V, T _J = 25°C, f = 1MHz	--	1300 74	--	pF

Thermal CharacteristicsT_C = 25°C unless otherwise noted

Symbol	Parameter	Min	Typ	Max	Units
R _{θJC}	Thermal Resistance, Junction-to-Case	--	0.85 / 0.43	1.02 / 0.51	°C/W

* Per Leg / Per Device

Package Marking and Ordering Information

Device Marking	Device	Package	Reel Size	Tape Width	Quantity
PD030120E2H	PD030120E2H	TO-247_3L	-	-	30
PD030120E2H_G	PD030120E2H_G	TO-247_3L	-	-	30

* PD030120E2H_G : RoHS Compliant

Typical Characteristics (Per Leg)

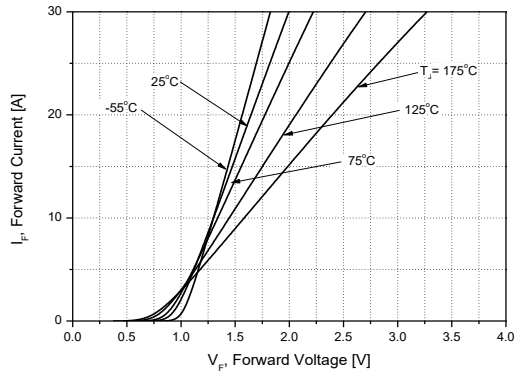

Figure 1. Forward Characteristics

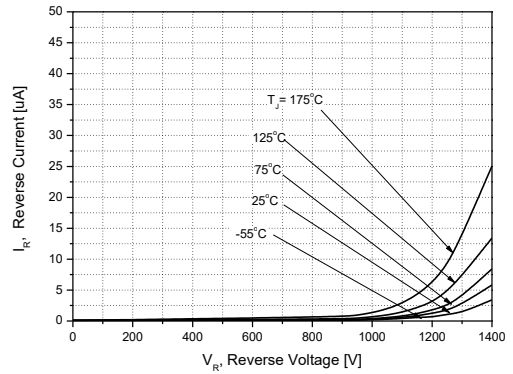

Figure 2. Reverse Characteristics

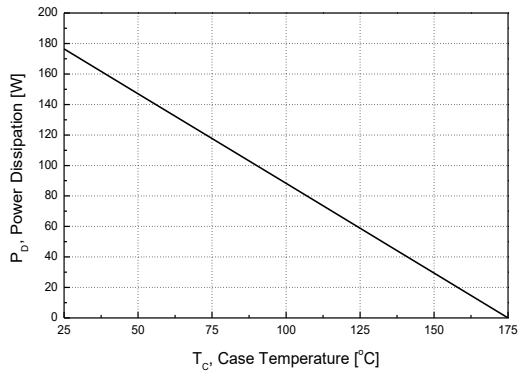

Figure 3. Power Dissipation

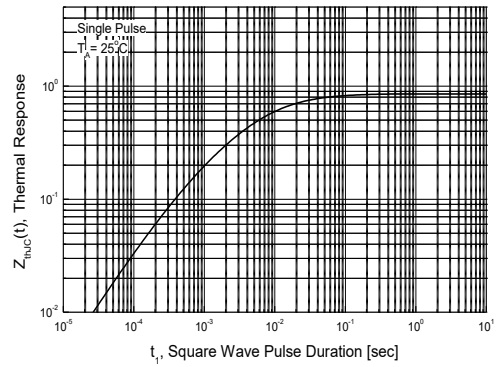

Figure 4. Transient Thermal Resistance

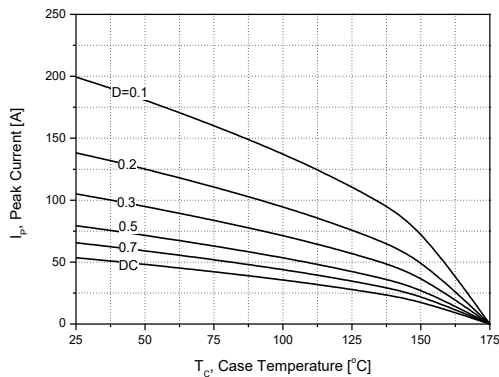

Figure 5. Peak Forward Current Derating

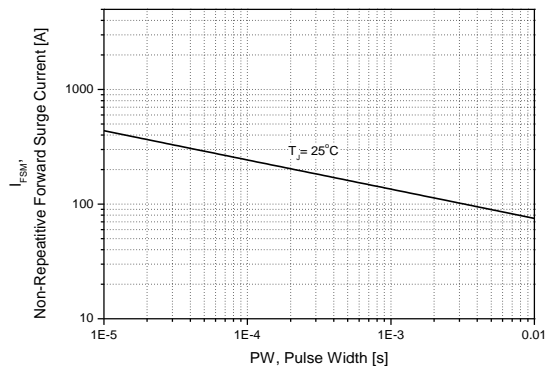

Figure 6. Non-Repetitive Peak Forward Surge Current vs. Pulse Duration

Typical Characteristics (Per Leg)

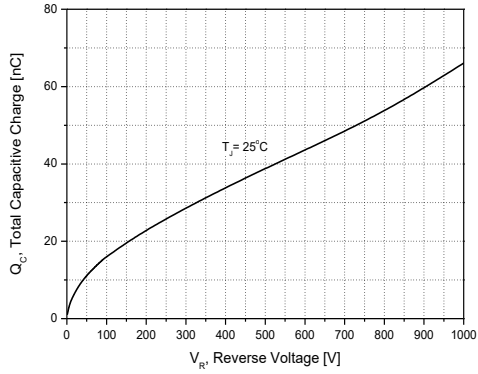

Figure 7. Total Capacitive Charge

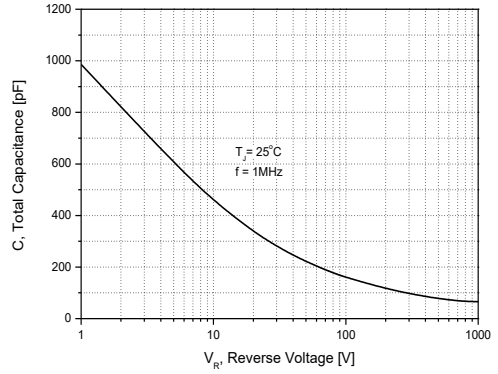

Figure 8. Total Capacitance

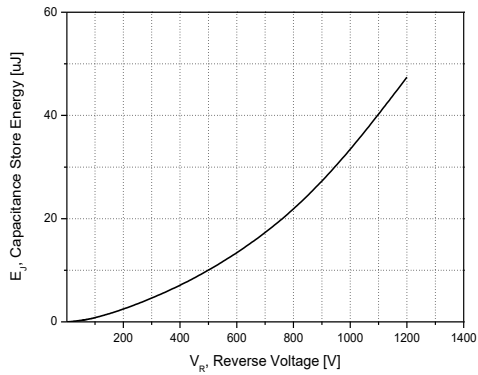

Figure 9. Capacitance Store Energy

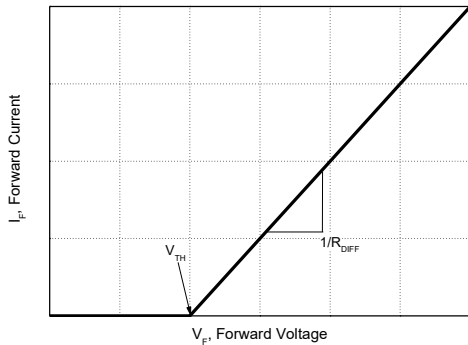

Figure 10. Equivalent Forward Current Curve

$$V_F = V_{TH} + R_{DIFF} \times I_F$$

Threshold Voltage (V_{TH})

$$V_{TH}(T_j) = -0.001 \times (T_j) + 0.930 \text{ [V]}$$

Differential Resistance (R_{DIFF})

$$R_{DIFF}(T_j) = A \times T_j^2 + B \times T_j + C \text{ [\Omega]}$$

$$A = 6.06 \times 10^{-7}$$

$$B = 1.19 \times 10^{-4}$$

$$C = 3.11 \times 10^{-2}$$

$$[T_j \text{ [}^\circ\text{C]}; -55^\circ\text{C} \leq T_j \leq 175^\circ\text{C}; I_F \leq 15 \text{ A}]$$

Package Information

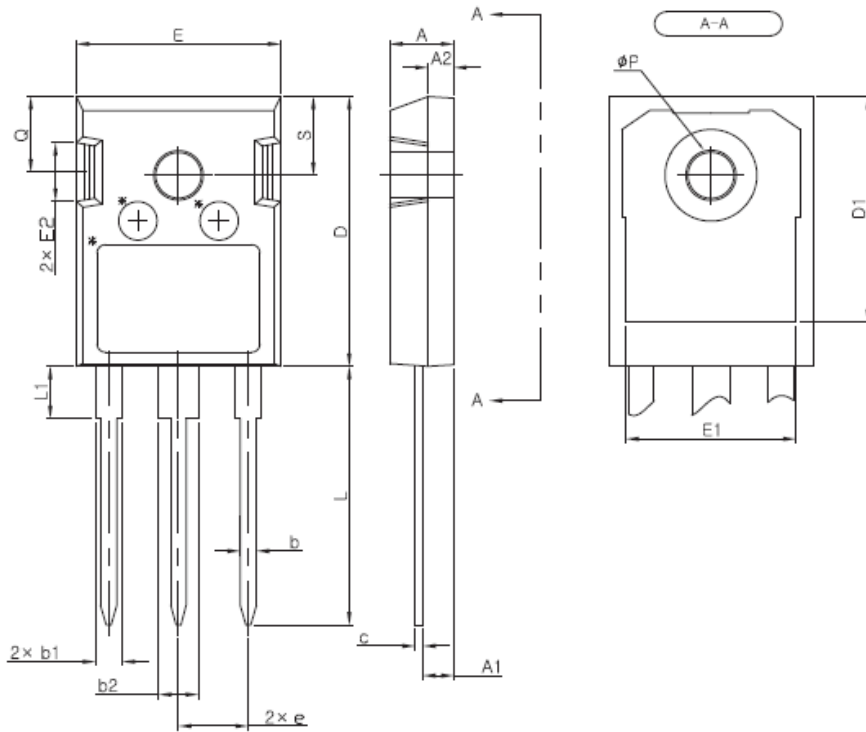

SYMBOL	MIN	NOM	MAX
A	4.80	5.00	5.20
A1	2.29	2.41	2.54
A2	1.90	2.00	2.10
b	1.10	1.20	1.30
b1	1.91	2.10	2.20
b2	2.92	3.10	3.20
c	0.50	0.60	0.70
D	20.80	21.07	21.34
D1	17.43	17.63	17.83
E	15.75	15.94	16.13
E1	13.06	13.26	13.46
E2	4.32	4.58	4.83
e	5.45 BSC		
L	19.81	20.19	20.57
L1	3.81	4.07	4.32
phi P	3.55	3.60	3.65
Q	5.59	5.90	6.20
S	6.15 BSC		

NOTE

1. THESE DIMENSION DO NOT INCLUDE MOLD PROTRUSION

Package Information

Inner Box

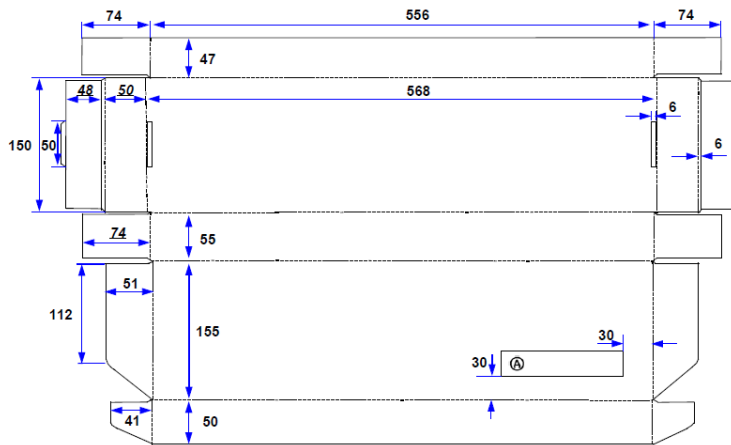

LOT NO 	PKG type 	QTY 	DATE
PART ID 	BOX NO 		
YESPOWERTECHNIX co.,ltd			

Outer Box

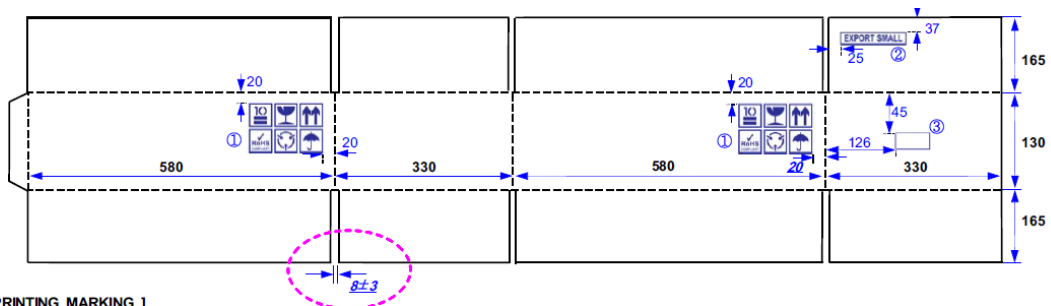

[BOX PRINTING MARKING]

①



MARKING SIZE (Each Symbol 30*30)
COLOR (DARK BLUE)

②

EXPORT SMALL

MARKING SIZE (112*20)
COLOR (DARK BLUE)

③

LABEL MARKING SIZE (75*35)
COLOR (DARK BLUE)

[NOTE]

- MATERIAL : KLB175*K180*KLB175*K180*KLB175 (SUK175*K200*K200*K200*SUK175)
- NAIL QTY : 3 PCS
- PRINTING TOLERANCE : MARKING SIZE(±3)
MARKING POSITION(±5)

PART ID	DATE
LOT NO	
QTY	
YESPOWERTECHNIX co.,ltd	

Notes

- A. Specifications mentioned in this publication are subject to change without notice.
- B. Before you use our Products, please contact our sales representative and verify the latest specifications.
- C. In order to prevent personal injury or fire arising from failure, please take safety measures such as complying with the derating characteristics, implementing redundant and fire prevention designs, and utilizing backups and fail-safe procedures.
- D. YES POWERTECHNIX shall have no responsibility for any damages arising out of the use of our products beyond the rating specified by YES POWERTECHNIX.
- E. The technical information specified herein is intended only to show the typical functions of and examples of application circuits for the Products.
- F. YES POWERTECHNIX does not grant you, explicitly or implicitly, any license to use or exercise intellectual property or other rights held by YES POWERTECHNIX or any other parties.
- G. YES POWERTECHNIX shall have no responsibility whatsoever for any dispute arising out of the use of such technical information.
- H. Please use the Products in accordance with any applicable environmental laws and regulations, such as the RoHS Directive.
- I. YES POWERTECHNIX shall have no responsibility for any damages or losses resulting non-compliance with any applicable laws or regulations.
- J. This document, in part or in whole, may not be reprinted or reproduced without prior consent of YES POWERTECHNIX.

