

## 120V N-Ch Power MOSFET

### Feature

- ◇ High Speed Power Switching, Logic level
- ◇ Enhanced Body diode dv/dt capability
- ◇ Enhanced Avalanche Ruggedness
- ◇ 100% UIS Tested, 100% Rg Tested
- ◇ Lead Free

### Application

- ◇ Synchronous Rectification in SMPS
- ◇ Hard Switching and High Speed Circuit
- ◇ Power Tools
- ◇ UPS
- ◇ Motor Control

$V_{DS}$		120	V
$R_{DS(on),typ}$	$V_{GS}=10V$	7.8	mΩ
$R_{DS(on),typ}$	$V_{GS}=4.5V$	8.6	mΩ
$I_D$ (Silicon Limited)		109	A

TO-220

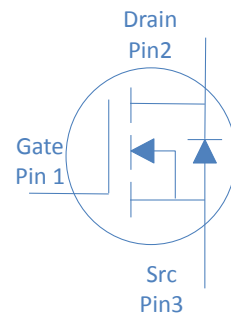

Part Number	Package	Marking
HGP100N12SL	TO-220	GP100N12SL

### Absolute Maximum Ratings at $T_J=25^\circ\text{C}$ (unless otherwise specified)

Parameter	Symbol	Conditions	Value	Unit
Continuous Drain Current (Silicon Limited)	$I_D$	$T_C=25^\circ\text{C}$	109	A
		$T_C=100^\circ\text{C}$	77	
Drain to Source Voltage	$V_{DS}$	-	120	V
Gate to Source Voltage	$V_{GS}$	-	$\pm 20$	V
Pulsed Drain Current	$I_{DM}$	-	300	A
Avalanche Energy, Single Pulse	$E_{AS}$	$L=0.4\text{mH}, T_C=25^\circ\text{C}$	320	mJ
Power Dissipation	$P_D$	$T_C=25^\circ\text{C}$	125	W
Operating and Storage Temperature	$T_J, T_{stg}$	-	-55 to 175	$^\circ\text{C}$

### Absolute Maximum Ratings

Parameter	Symbol	Max	Unit
Thermal Resistance Junction-Case	$R_{\theta JC}$	0.7	$^\circ\text{C/W}$
Thermal Resistance Junction-Ambient	$R_{\theta JA}$	50	$^\circ\text{C/W}$

## Electrical Characteristics at $T_j=25^\circ\text{C}$ (unless otherwise specified)

### Static Characteristics

Parameter	Symbol	Conditions	Value			Unit
			min	typ	max	
Drain to Source Breakdown Voltage	$V_{(BR)DSS}$	$V_{GS}=0V, I_D=250\mu A$	120	-	-	V
Gate Threshold Voltage	$V_{GS(th)}$	$V_{GS}=V_{DS}, I_D=250\mu A$	1.4	1.7	2.4	
Zero Gate Voltage Drain Current	$I_{DSS}$	$V_{GS}=0V, V_{DS}=120V, T_j=25^\circ\text{C}$	-	-	1	$\mu A$
		$V_{GS}=0V, V_{DS}=120V, T_j=100^\circ\text{C}$	-	-	100	
Gate to Source Leakage Current	$I_{GSS}$	$V_{GS}=\pm 20V, V_{DS}=0V$	-	-	$\pm 100$	nA
Drain to Source on Resistance	$R_{DS(on)}$	$V_{GS}=10V, I_D=20A$	-	7.8	10	$m\Omega$
		$V_{GS}=4.5V, I_D=20A$	-	8.6	13.5	$m\Omega$
Transconductance	$g_{fs}$	$V_{DS}=5V, I_D=20A$	-	70	-	S
Gate Resistance	$R_G$	$V_{GS}=0V, V_{DS}$ Open, $f=1\text{MHz}$	-	2.5	-	$\Omega$

### Dynamic Characteristics

Input Capacitance	$C_{iss}$	$V_{GS}=0V, V_{DS}=60V, f=1\text{MHz}$	-	4730	-	pF
Output Capacitance	$C_{oss}$		-	242	-	
Reverse Transfer Capacitance	$C_{rss}$		-	11	-	
Total Gate Charge	$Q_g(10V)$	$V_{DD}=60V, I_D=20A, V_{GS}=10V$	-	66	-	nC
Total Gate Charge	$Q_g(4.5V)$		-	32	-	
Gate to Source Charge	$Q_{gs}$		-	14	-	
Gate to Drain (Miller) Charge	$Q_{gd}$		-	6	-	
Turn on Delay Time	$t_{d(on)}$	$V_{DD}=60V, I_D=20A, V_{GS}=10V, R_G=10\Omega,$	-	18	-	ns
Rise time	$t_r$		-	21	-	
Turn off Delay Time	$t_{d(off)}$		-	39	-	
Fall Time	$t_f$		-	19	-	

### Reverse Diode Characteristics

Diode Forward Voltage	$V_{SD}$	$V_{GS}=0V, I_F=20A$	-	0.9	1.2	V
Reverse Recovery Time	$t_{rr}$	$V_R=60V, I_F=20A, di_F/dt=500A/\mu s$	-	60	-	ns
Reverse Recovery Charge	$Q_{rr}$		-	390	-	nC

Fig 1. Typical Output Characteristics

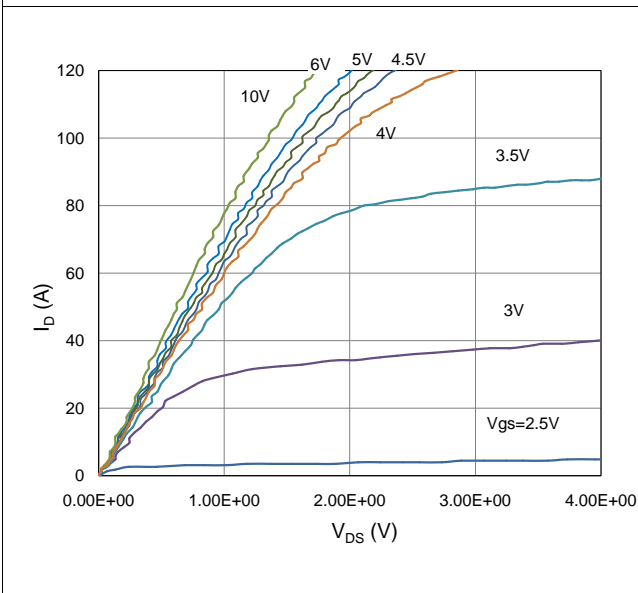

Figure 2. On-Resistance vs. Gate-Source Voltage

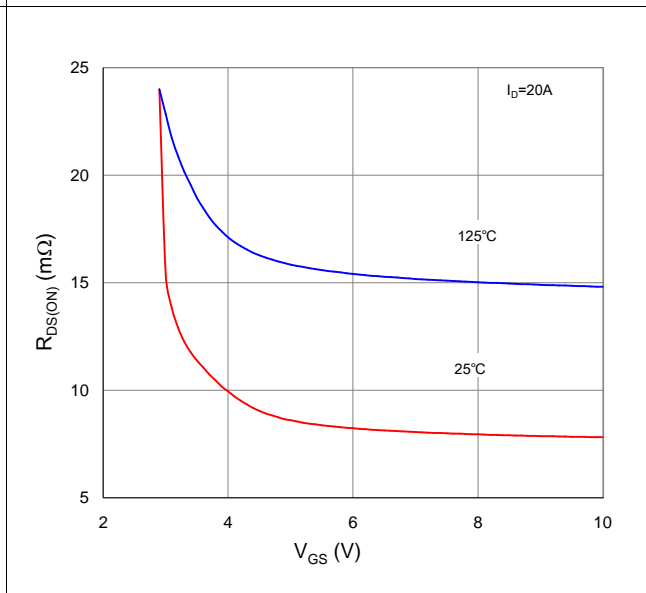

Figure 3. On-Resistance vs. Drain Current and Gate Voltage

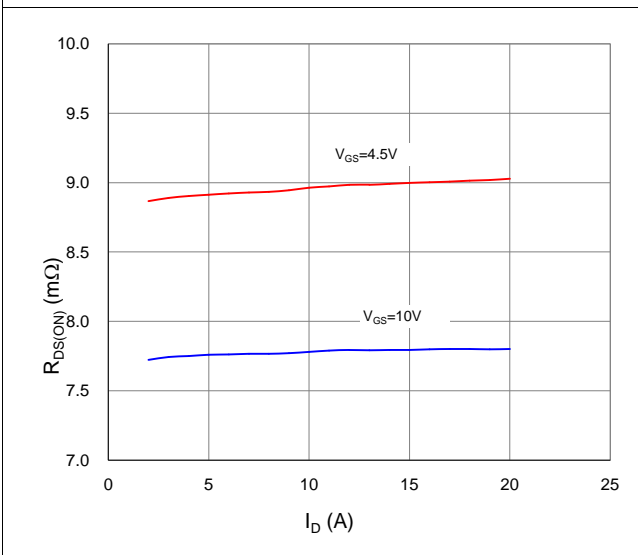

Figure 4. Normalized On-Resistance vs. Junction Temperature

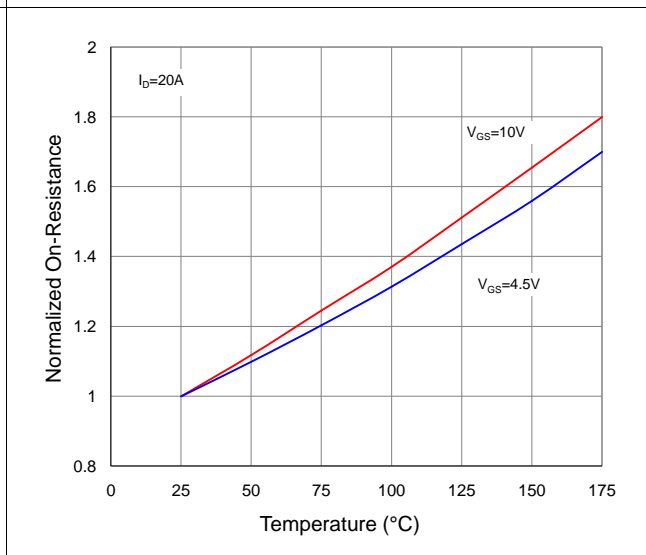

Figure 5. Typical Transfer Characteristics

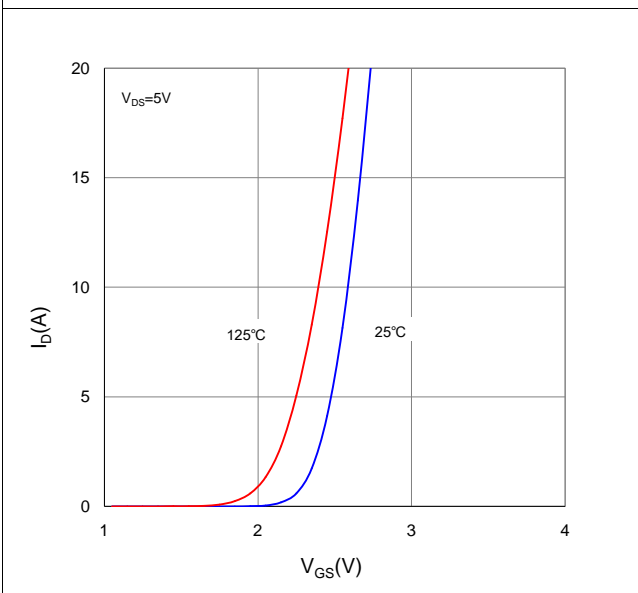

Figure 6. Typical Source-Drain Diode Forward Voltage

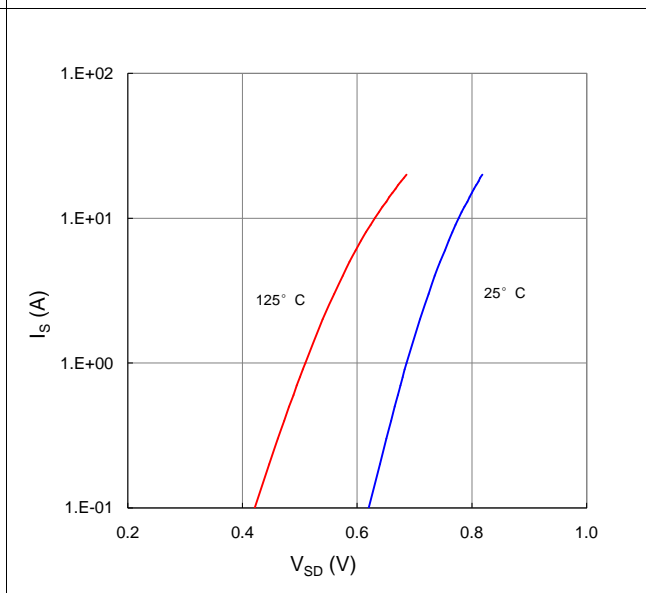

Figure 7. Typical Gate-Charge vs. Gate-to-Source Voltage

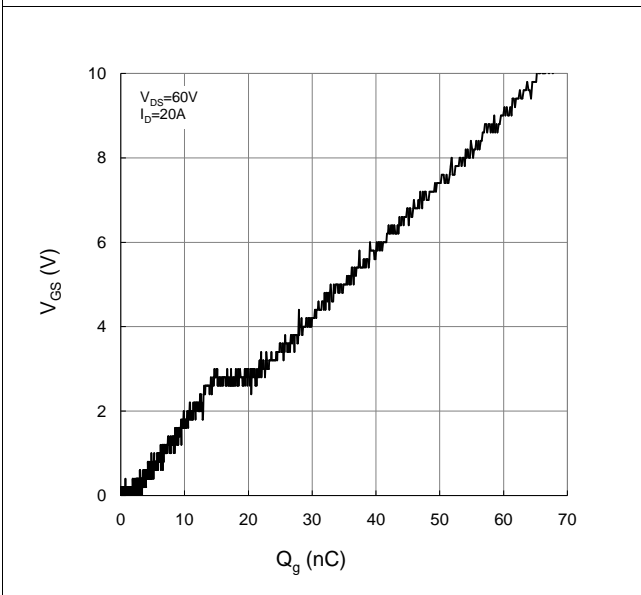

Figure 8. Typical Capacitance vs. Drain-to-Source Voltage

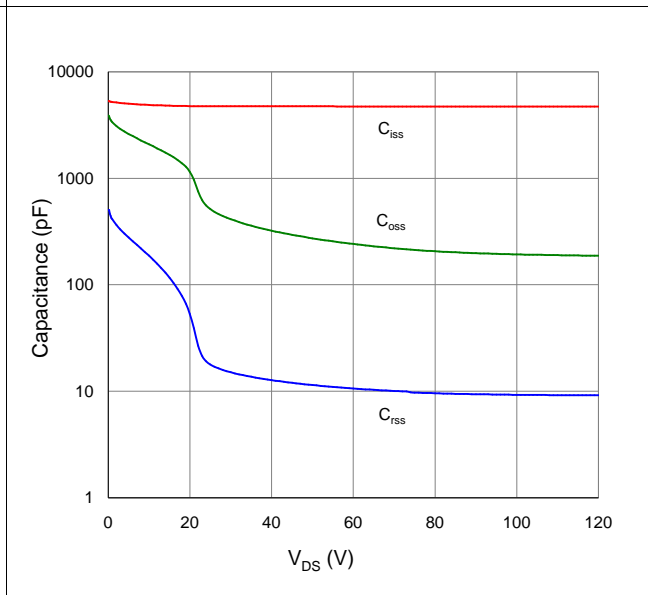

Figure 9. Maximum Safe Operating Area

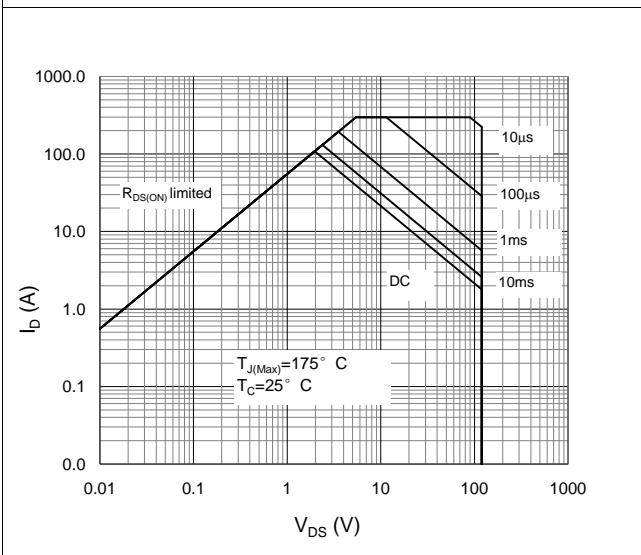

Figure 10. Maximum Drain Current vs. Case Temperature

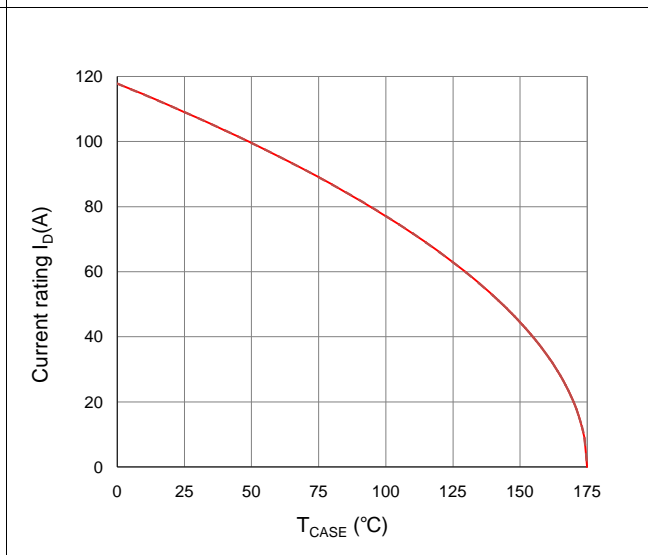
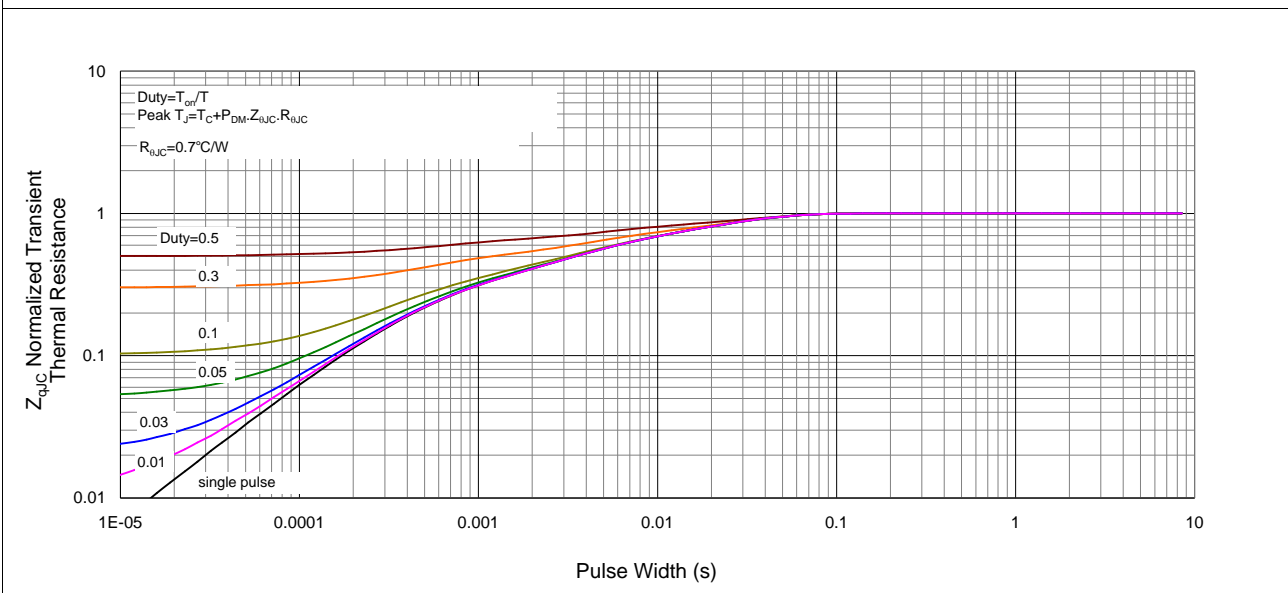
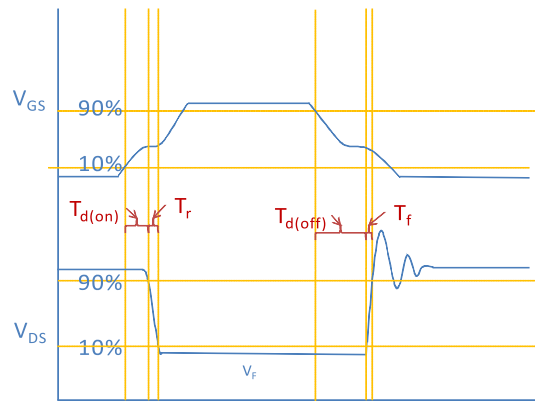

Figure 11. Normalized Maximum Transient Thermal Impedance, Junction-to-Case



### Inductive switching Test



### Gate Charge Test

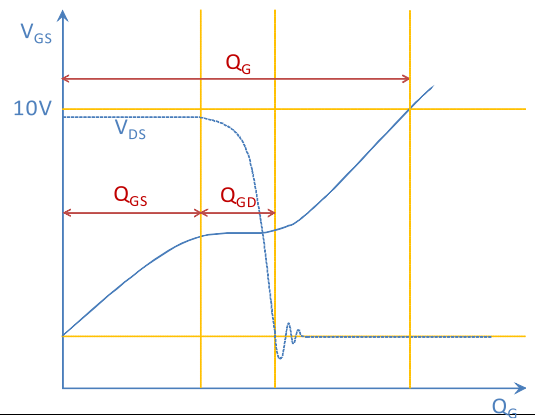
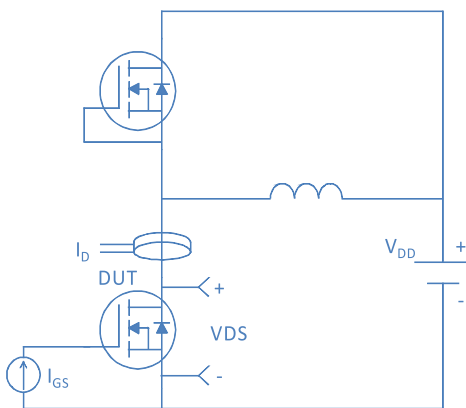

### Uclamped Inductive Switching (UIS) Test

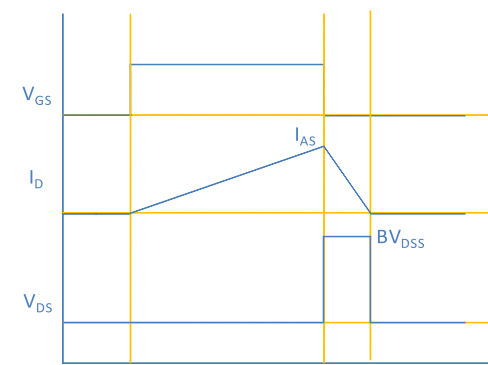

### Diode Recovery Test

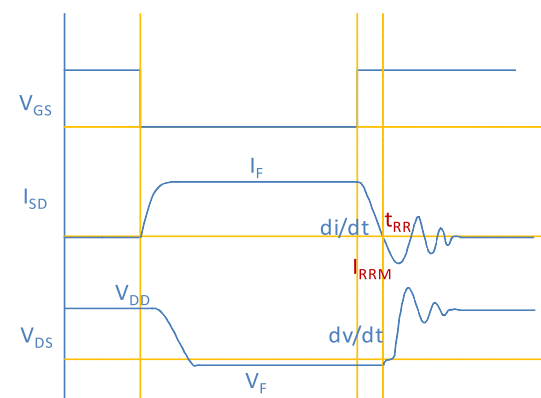
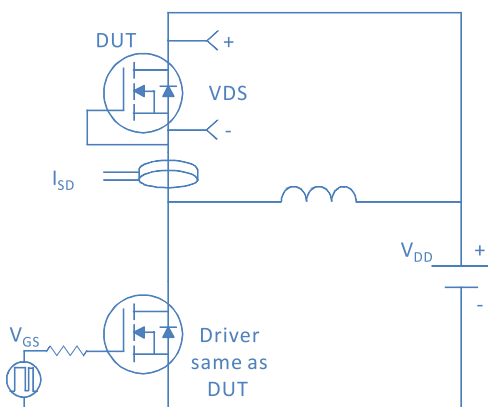

## Package Outline

TO-220, 3 leads

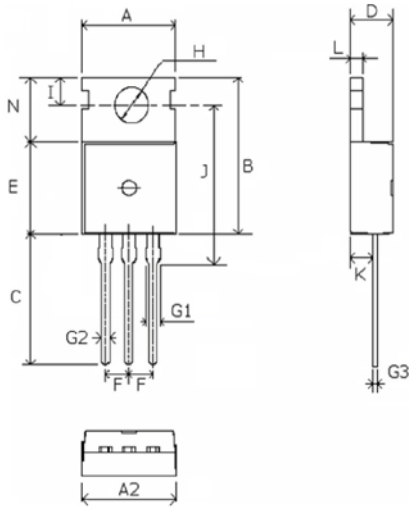

Dimensions in mm unless otherwise specified

Symbol	Min	Nom	Max
A	9.66	9.97	10.28
A2	9.80	10.00	10.20
B	15.60	15.70	15.80
C	12.70	13.48	14.27
D	4.30	4.50	4.70
E	9.00	9.20	9.40
F		2.54	
G1	1.32	1.52	1.72
G2	0.70	0.82	0.95
G3	0.45	0.52	0.60
H	3.50	3.60	3.70
I	2.70	2.80	2.90
J	15.70	15.97	16.25
K	2.20	2.40	2.60
L	1.15	1.27	1.40
N	6.40	6.60	6.80