

**65V N-Ch Power MOSFET**
**Feature**

- ◇ High Speed Power Switching
- ◇ Enhanced Body diode dv/dt capability
- ◇ Enhanced Avalanche Ruggedness
- ◇ 100% UIS Tested, 100% Rg Tested
- ◇ Lead Free, Halogen Free

$V_{DS}$	65	V
$R_{DS(on),typ}$	1.35	mΩ
$I_D$ (Silicon Limited)	363	A
$I_D$ (Package Limited)	180	A

**Application**

- ◇ Synchronous Rectification in SMPS
- ◇ Hard Switching and High Speed Circuit
- ◇ DC/DC in Telecoms and Industrial

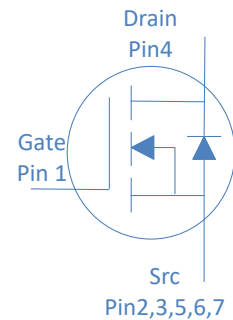
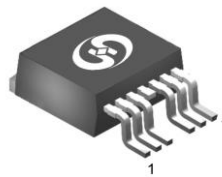
**TO-263-7**

Part Number	Package	Marking
HGB016NE6A	TO-263-7	GB016NE6A

**Absolute Maximum Ratings at  $T_j=25^{\circ}\text{C}$  (unless otherwise specified)**

Parameter	Symbol	Conditions	Value	Unit
Continuous Drain Current (Silicon Limited)	$I_D$	$T_C=25^{\circ}\text{C}$	363	A
		$T_C=100^{\circ}\text{C}$	257	
		$T_C=25^{\circ}\text{C}$	180	
Drain to Source Voltage	$V_{DS}$	-	65	V
Gate to Source Voltage	$V_{GS}$	-	$\pm 20$	V
Pulsed Drain Current	$I_{DM}$	-	900	A
Avalanche Energy, Single Pulse	$E_{AS}$	$L=0.1\text{mH}, T_C=25^{\circ}\text{C}$	180	mJ
Power Dissipation	$P_D$	$T_C=25^{\circ}\text{C}$	333	W
Operating and Storage Temperature	$T_J, T_{stg}$	-	-55 to 175	$^{\circ}\text{C}$

**Absolute Maximum Ratings**

Parameter	Symbol	Max	Unit
Thermal Resistance Junction-Ambient	$R_{\theta JA}$	60	$^{\circ}\text{C}/\text{W}$
Thermal Resistance Junction-Case	$R_{\theta JC}$	0.45	$^{\circ}\text{C}/\text{W}$

**Electrical Characteristics at  $T_j=25^{\circ}\text{C}$  (unless otherwise specified)**
**Static Characteristics**

Parameter	Symbol	Conditions	Value			Unit
			min	typ	max	
Drain to Source Breakdown Voltage	$V_{(BR)DSS}$	$V_{GS}=0V, I_D=250\mu A$	65	-	-	V
Gate Threshold Voltage	$V_{GS(th)}$	$V_{GS}=V_{DS}, I_D=250\mu A$	2.0	2.5	4.0	V
Zero Gate Voltage Drain Current	$I_{DSS}$	$V_{GS}=0V, V_{DS}=60V, T_j=25^{\circ}\text{C}$	-	-	1	$\mu A$
		$V_{GS}=0V, V_{DS}=60V, T_j=100^{\circ}\text{C}$	-	-	100	
Gate to Source Leakage Current	$I_{GSS}$	$V_{GS}=\pm 20V, V_{DS}=0V$	-	-	$\pm 100$	nA
Drain to Source on Resistance	$R_{DS(on)}$	$V_{GS}=10V, I_D=20A$	-	1.35	1.6	$m\Omega$
Transconductance	$g_{fs}$	$V_{DS}=5V, I_D=20A$	-	80	-	S
Gate Resistance	$R_G$	$V_{GS}=0V, V_{DS}$ Open, $f=1\text{MHz}$	-	0.63	-	$\Omega$

**Dynamic Characteristics**

Input Capacitance	$C_{iss}$	$V_{GS}=0V, V_{DS}=30V, f=1\text{MHz}$	-	8671	-	pF
Output Capacitance	$C_{oss}$		-	3042	-	
Reverse Transfer Capacitance	$C_{rss}$		-	161	-	
Total Gate Charge	$Q_g(10V)$	$V_{DD}=30V, I_D=20A, V_{GS}=10V$	-	130	-	nC
Gate to Source Charge	$Q_{gs}$		-	24	-	
Gate to Drain (Miller) Charge	$Q_{gd}$		-	34	-	
Turn on Delay Time	$t_{d(on)}$	$V_{DD}=30V, I_D=20A, V_{GS}=10V, R_G=10\Omega,$	-	30	-	ns
Rise time	$t_r$		-	28	-	
Turn off Delay Time	$t_{d(off)}$		-	70	-	
Fall Time	$t_f$		-	32	-	

**Reverse Diode Characteristics**

Diode Forward Voltage	$V_{SD}$	$V_{GS}=0V, I_F=20A$	-	0.9	1.2	V
Reverse Recovery Time	$t_{rr}$	$V_R=30V, I_F=20A, di_F/dt=100A/\mu s$	-	72	-	ns
Reverse Recovery Charge	$Q_{rr}$		-	100	-	nC

Fig 1. Typical Output Characteristics

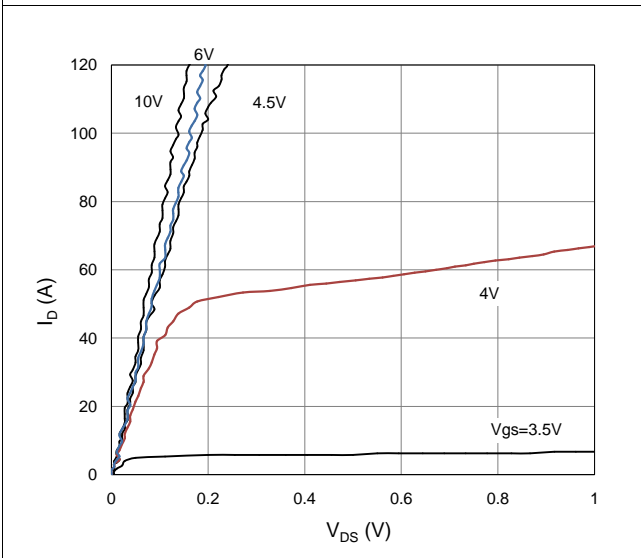

Figure 2. On-Resistance vs. Gate-Source Voltage

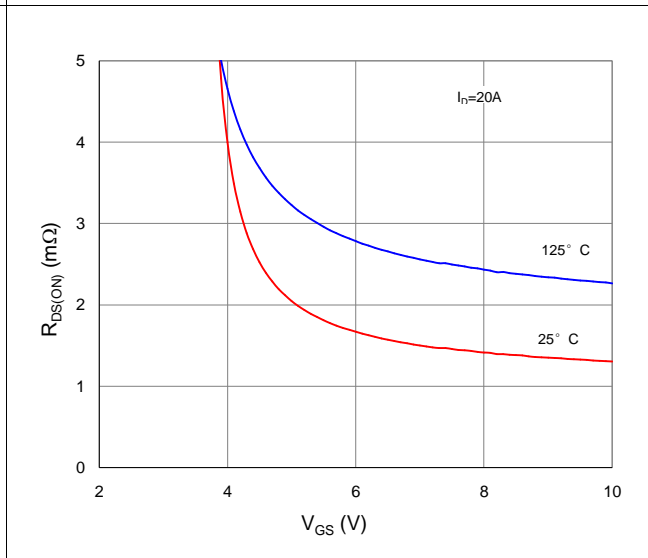

Figure 3. On-Resistance vs. Drain Current and Gate Voltage

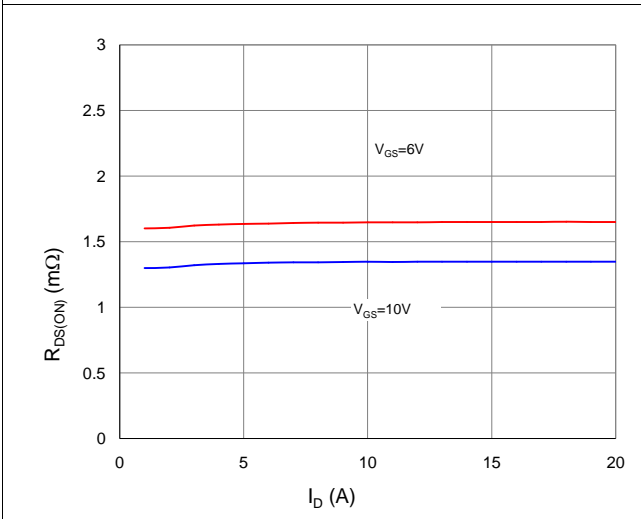

Figure 4. Normalized On-Resistance vs. Junction Temperature

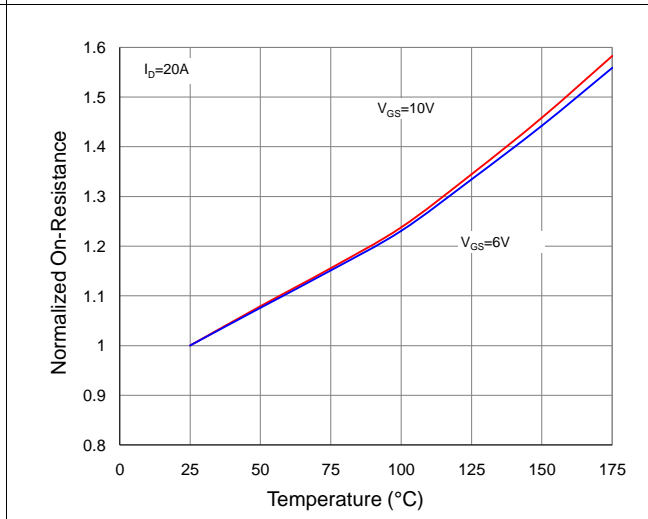

Figure 5. Typical Transfer Characteristics

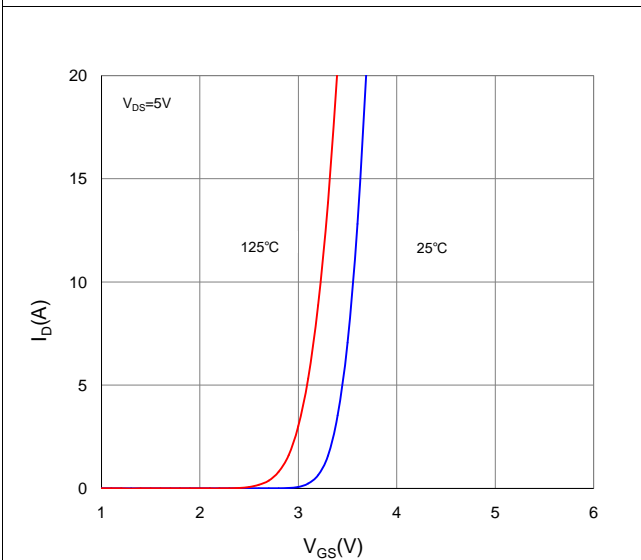

Figure 6. Typical Source-Drain Diode Forward Voltage

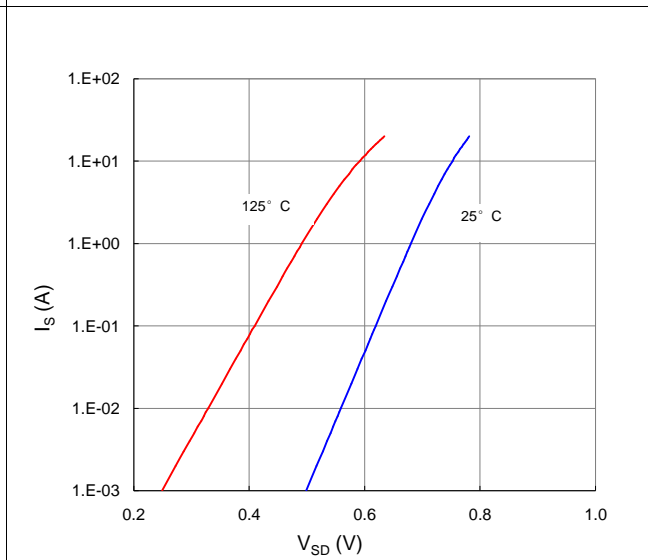

Figure 7. Typical Gate-Charge vs. Gate-to-Source Voltage

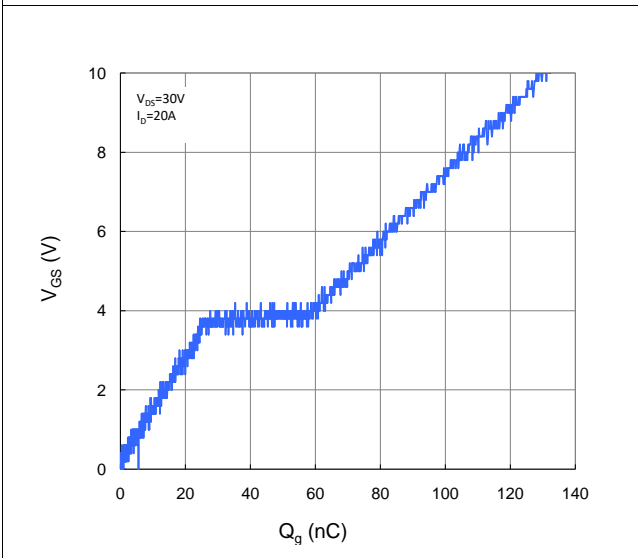

Figure 8. Typical Capacitance vs. Drain-to-Source Voltage

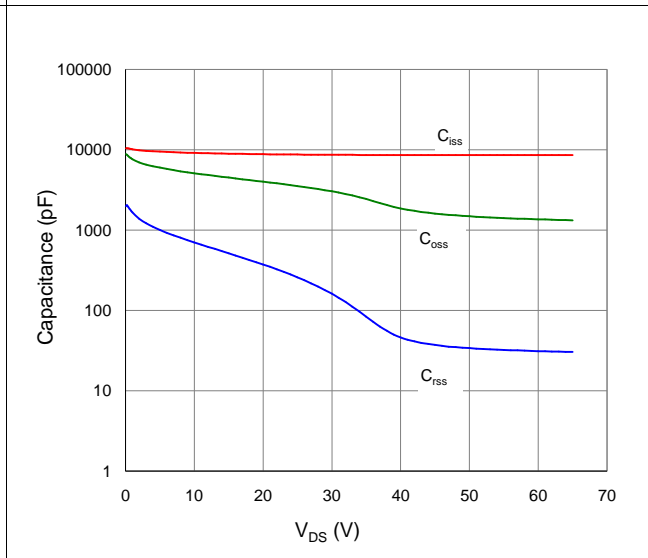

Figure 9. Maximum Safe Operating Area

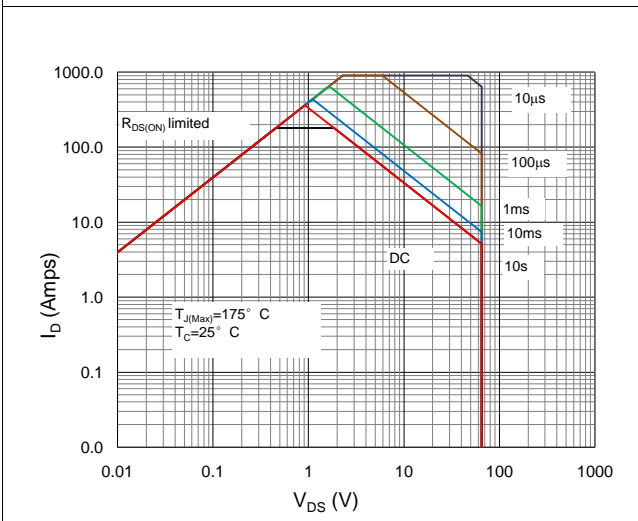

Figure 10. Maximum Drain Current vs. Case Temperature

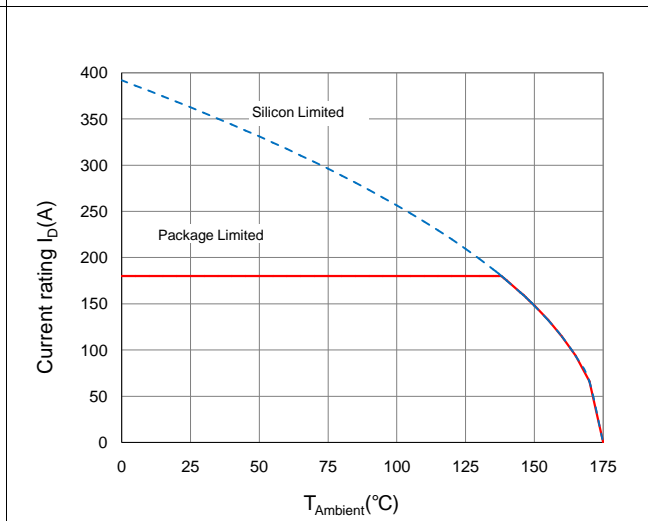
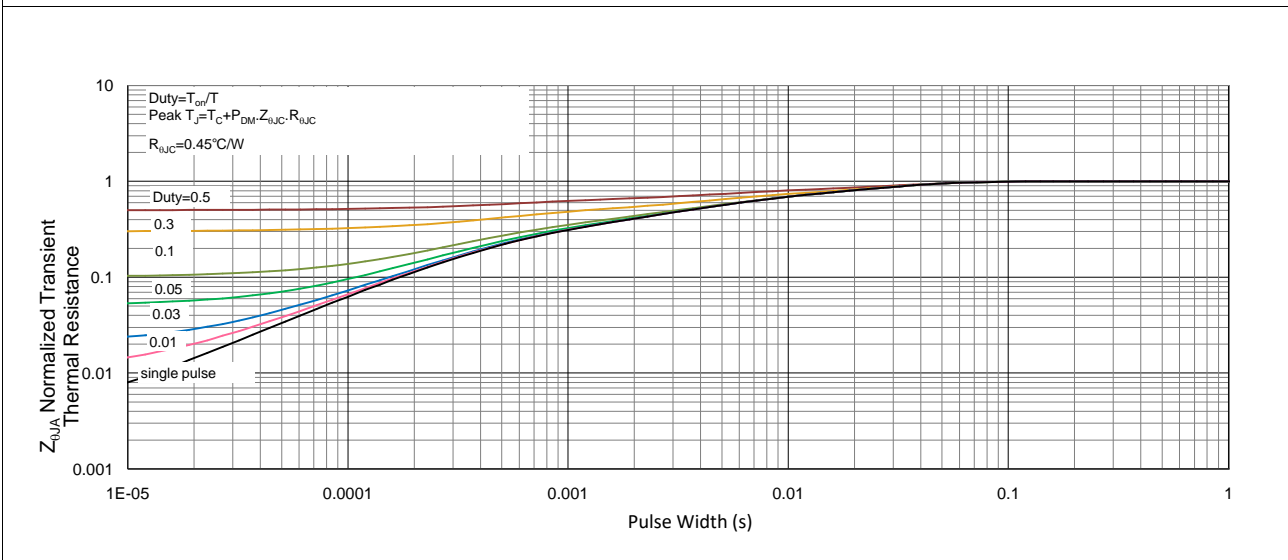
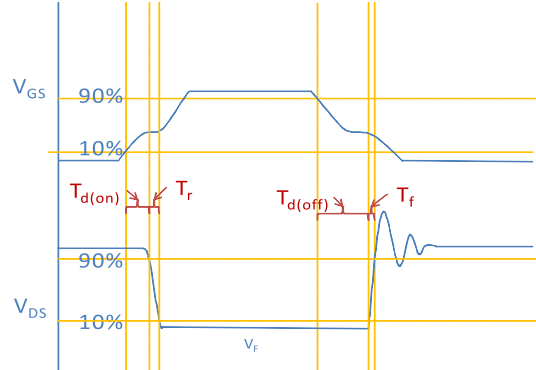
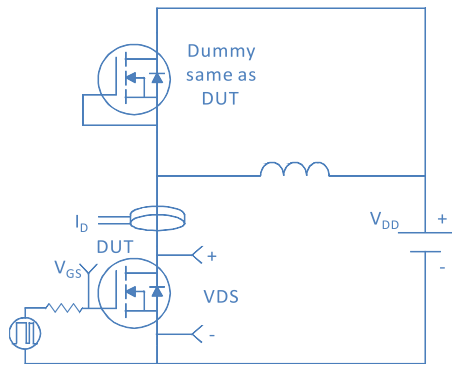

Figure 11. Normalized Maximum Transient Thermal Impedance, Junction-to-Ambient



Inductive switching Test



Gate Charge Test

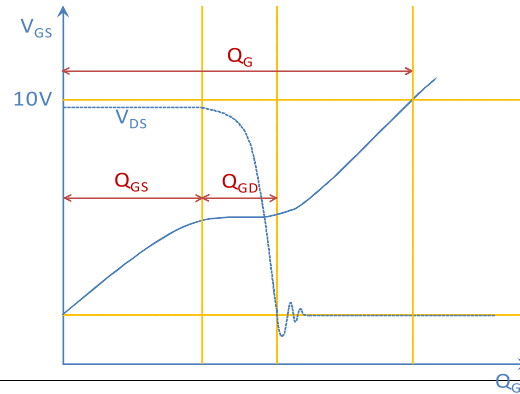
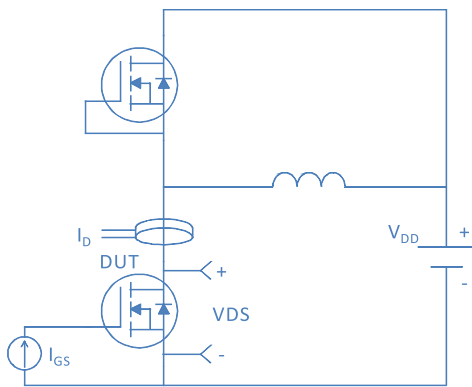

Uclamped Inductive Switching (UIS) Test

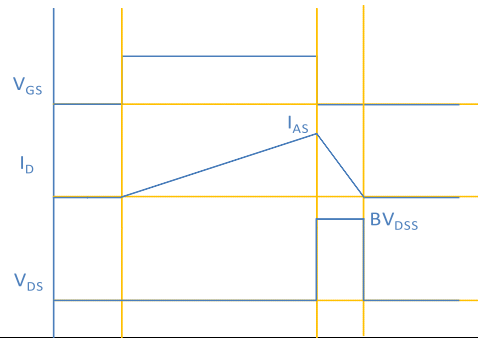
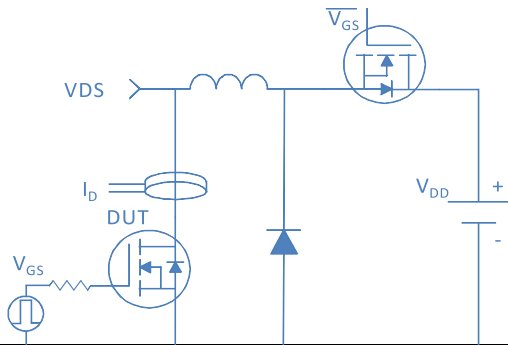

Diode Recovery Test

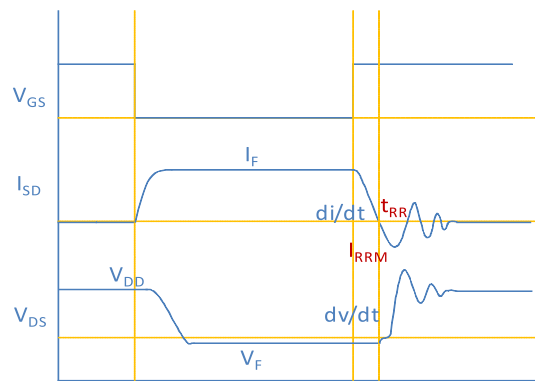
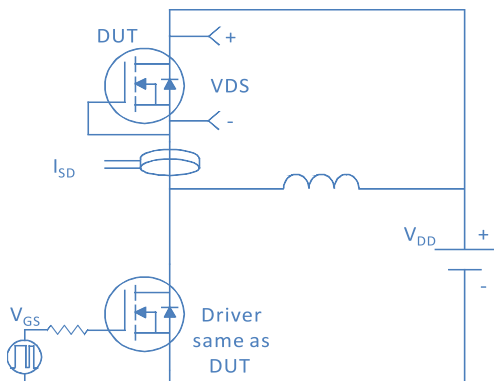

Package Outline

TO-263-7, 7 leads

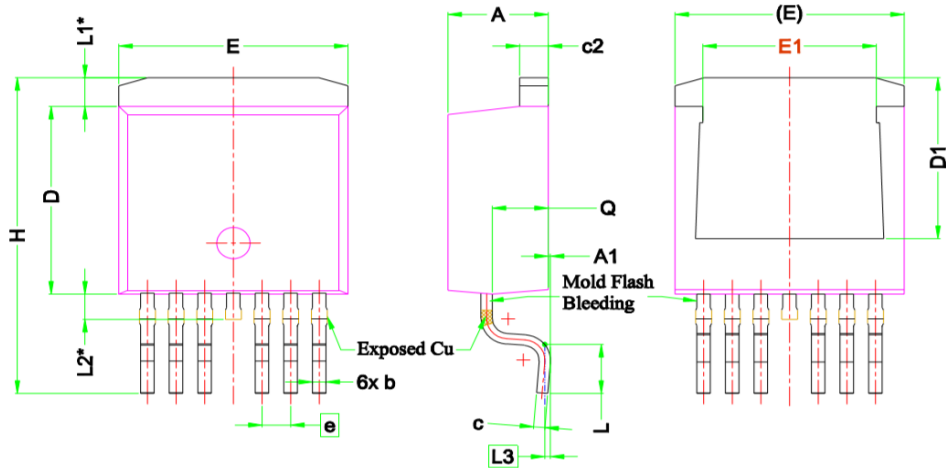

SYMBOL	DIMENSIONS		
	MIN.	NOM.	MAX.
A	4.24	4.44	4.64
A1	0.00	0.10	0.25
b	0.50	0.60	0.70
c	0.40	0.50	0.60
c2	1.15	1.27	1.40
D	8.82	8.92	9.02
D1	6.86	7.65	—
E	9.96	10.16	10.36
E1	6.89	7.77	7.89
e	1.27 BSC		
H	14.61	15.00	15.88
L	1.78	2.32	2.79
L1	1.36 REF.		
L2	1.20 REF.		
L3	0.25 BSC		
Q	2.30	2.48	2.70